



Deze download wordt u gratis aangeboden door Pick-upnaalden.nl

Web : www.pickupnaalden.com
Email : info@pick-upnaalden.nl
Facebook : www.facebook.com/pickupnaalden
Twitter : twitter.com/Pickupnaalden
Google+ : https://plus.google.com/+FCaris_pickupnaalden

KENWOOD

FULL AUTOMATIC TURNTABLE

KD-491F
KD-491FC

INSTRUCTION MANUAL

KENWOOD CORPORATION

B60-0445-08 ©(K, Y, X, T)T

Introduction

Your choice of this product indicates that you are a devotee to excellence in sound reproduction.

We appreciate your patronage and take pride in the long tradition of quality components that our company represents.

So that you can get the most out of your unit, we suggest that you take the time to read through this manual before you hook up and operate your system. This will acquaint you with operating features and system-connection considerations so that your listening pleasure will be enhanced right from the start. You will notice that in all aspects of planning, engineering, styling, operating convenience and adaptability we have sought to anticipate your needs and desires.

Keep this manual handy for future reference.

For your records

Record the serial number, found on the back of the unit, in the spaces designated on the warranty card, and in the space provided below. Refer to the model and serial numbers whenever you call upon your dealer for information or service on this product.

Model _____ Serial Number _____

Unpacking



Unpack the unit carefully and make sure that all accessories are put aside so they will not be lost.

Examine the unit for any possibility of shipping damage. If your unit is damaged or fails to operate, notify your dealer immediately. If your unit was shipped to you directly, notify the shipping company without delay. Only the consignee (the person or company receiving the unit) can file a claim against the carrier for shipping damage.

We recommend that you retain the original carton and packing materials for use should you transport or ship the unit in the future.

Contents

Caution: Read the pages marked  carefully to ensure safe operation.

 Before applying power.....	3	Connections.....	8
 Safety precautions.....	3	Operating instructions.....	9
 IMPORTANT SAFEGUARDS.....	4	Maintenance.....	11
Parts nomenclature.....	6	In case of difficulty.....	12
Assembly.....	7	Specifications.....	12

⚠ Caution: Read this page carefully to ensure safe operation.

Before applying power

For the U.S.A. and Canada

Important!

Units shipped to the U.S.A. and Canada are designed for operation on 120 volts AC only.

Safety precaution for a Polarized AC plug
However, some products may be supplied with a non-polarized plug.

CAUTION: TO PREVENT ELECTRIC SHOCK DO NOT USE THIS (POLARIZED) PLUG WITH AN EXTENSION CORD, RECEPTACLE OR OTHER OUTLET UNLESS THE BLADES CAN BE FULLY INSERTED TO PREVENT BLADE EXPOSURE.

For the United Kingdom

Important!

Units shipped to the U.K. are designed for operation on 240 volts AC only.

The mains plug must be removed from the wall socket prior to any internal examination.

The wires in this mains lead are coloured in accordance with the following code:

Blue Neutral
Brown Live

The wires in this mains lead must be connected to the terminals in the plug as follows:

Wire colour	Plug terminal marking
Blue	N or Black
Brown	L or Red

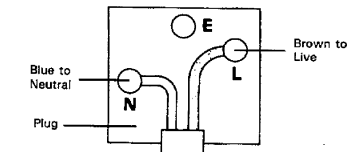

Notes:

1. If a 13-amp plug is used, this must be fitted with a 5-amp fuse.
2. If a 3-pin plug with earthing contact is used, no wire must be connected to the E terminal.

For Australia and Europe

Important!

Units shipped to Australia are designed for operation on 240 V AC only.

Units shipped to Europe are designed for operation on 230 V AC only.

For other countries

Important!

Units shipped to countries other than the above countries are equipped with an AC voltage selector switch under the turntable platter. Refer to the following paragraph for the proper setting of this switch.

AC voltage selection

This unit operates on 110-120 or 220-240 volts AC. The AC voltage selector switch under the turntable platter is set to the voltage that prevails in the area to which the unit is shipped. Before connecting the power cord to your AC outlet, make sure that the setting position of this switch matches your line voltage. If not, it must be set to your voltage in accordance with the following direction.

Note:

Our warranty does not cover damage caused by excessive line voltage due to improper setting of the AC voltage selector switch.

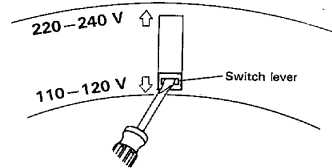





Move switch lever to match your line voltage with a small screwdriver or other pointed tool.

AC voltage selector switch

Safety precautions

WARNING: TO PREVENT FIRE OR ELECTRIC SHOCK, DO NOT EXPOSE THIS APPLIANCE TO RAIN OR MOISTURE.

 CAUTION RISK OF ELECTRIC SHOCK DO NOT OPEN		CAUTION: TO REDUCE THE RISK OF ELECTRIC SHOCK, DO NOT REMOVE COVER (OR BACK). NO USER-SERVICEABLE PARTS INSIDE, REFER SERVICING TO QUALIFIED SERVICE PERSONNEL.
		THE LIGHTNING FLASH WITH ARROWHEAD SYMBOL, WITHIN AN EQUILATERAL TRIANGLE, IS INTENDED TO ALERT THE USER TO THE PRESENCE OF UNINSULATED "DANGEROUS VOLTAGE" WITHIN THE PRODUCT'S ENCLOSURE THAT MAY BE OF SUFFICIENT MAGNITUDE TO CONSTITUTE A RISK OF ELECTRIC SHOCK TO PERSONS.
		THE EXCLAMATION POINT WITHIN AN EQUILATERAL TRIANGLE IS INTENDED TO ALERT THE USER TO THE PRESENCE OF IMPORTANT OPERATING AND MAINTENANCE (SERVICING) INSTRUCTIONS IN THE LITERATURE ACCOMPANYING THE APPLIANCE.

IMPORTANT SAFEGUARDS

⚠ Caution : Read this page carefully to ensure safe operation.

Please read all of the safety and operating instructions before operating this unit. For best results, follow all warnings placed on the unit and adhere to the operating and use instructions. These safety and operating instructions should be retained for future reference.

1. Power sources — The unit should be connected to a power supply only of the type described in the operating instructions or as marked on the appliance.

2. Power-cord protection — Power-supply cords should be routed so that they are not likely to be walked on or pinched by items placed upon or against them, pay particular attention to cords at plugs, convenience receptacles, and the point where they exit from the unit.

Never pull or stretch the cord.



3. Grounding or polarization — The precautions should be taken so that the grounding or polarization means of this unit is not defeated.

4. Ventilation — The unit should be situated so that its location or position does not interfere with its proper ventilation.

To maintain good ventilation, do not put records or a table-cloth on the unit. Place the unit at least 10 cm away from the walls.

Do not use the unit on a bed, sofa, rug or similar surface that may block the ventilation openings.



5. Water and moisture — The unit should not be used near water — for example, near a bathtub, washbowl, kitchen sink, laundry tub, in a wet basement, or near a swimming pool, etc.

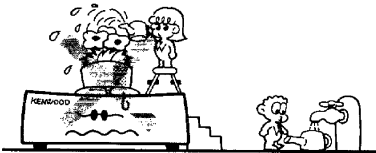

6. Temperature — The unit may not function properly if used at extremely low, or freezing temperatures. The ideal ambient temperature is above +5°C (41°F).

7. Heat — The unit should be situated away from heat sources such as radiators, heat registers, stoves, or other units (including amplifiers) that produce heat.

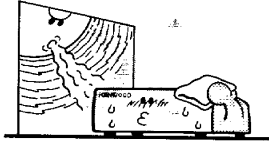

8. Electric shock — Care should be taken so that objects do not fall and liquid is not spilled into the enclosure through openings. If a metal object, such as a hair pin or a needle, comes into contact with the inside of this unit, a dangerous electric shock may result. For families with children, never permit children to put anything, especially metal, inside this unit.

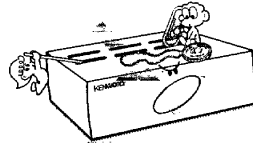

9. Enclosure removal — Never remove the enclosure. If the internal parts are touched accidentally, a serious electric shock might occur.

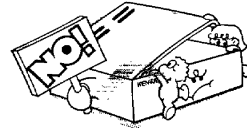

10. Magnetic fields — Keep the unit away from sources of magnetic fields such as TV sets, speaker systems, radios, motorized toys or magnetized objects.

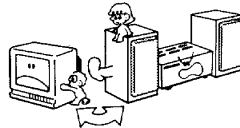

11. Cleaning — Do not use volatile solvents such as alcohol, paint thinner, gasoline, or benzine, etc. to clean the cabinet. Use a clean dry cloth.

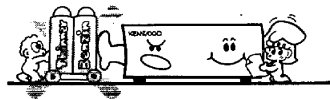

⚠ Caution : Read this page carefully to ensure safe operation.

12. Carts and stands — An appliance and cart combination should be moved with care. Quick stops, excessive force, and uneven surfaces may cause the appliance and cart combination to overturn.



13. Nonuse periods — The power cord of the unit should be unplugged from the outlet when left unused for a long period of time.

14. Abnormal smell — If an abnormal smell or smoke is detected, immediately turn the power OFF and pull out the power cord. Contact your dealer or nearest service center.

POWER OFF!



15. Damage requiring service — The unit should be serviced by qualified service personnel when:

- A.** The power-supply cord or the plug has been damaged; or
- B.** Objects have fallen, or liquid has been spilled into the unit; or
- C.** The unit has been exposed to rain; or
- D.** The unit does not appear to operate normally or exhibits a marked change in performance; or
- E.** The unit has been dropped, or the enclosure damaged.

16. Servicing — The user should not attempt to service the unit beyond that described in the operating instructions. All other servicing should be referred to qualified service personnel.

17. Outdoor antenna grounding — If an outside antenna is connected to the receiver, be sure the antenna system is grounded so as to provide some protection against voltage surges and built up static charges. Section 810 of the National Electrical Code, ANSI/ NFPA No. 70—1984, provides information with respect to proper grounding of the mast and supporting structure, grounding of the lead-in wire to an antenna discharge unit, size of grounding con-

ductors, location of antenna-discharge unit, connection to grounding electrodes, and requirements for the grounding electrode. See Figure.

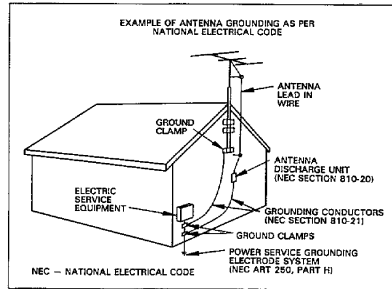

18. Power lines — An outdoor antenna should be located away from power lines.

Notes:

- 1. Item 3 is not required except for grounded or polarized equipment.**
- 2. Item 17 and 18 are not required except for units provided with antenna terminals.**
- 3. Item 17 complies with UL in the U.S.A.**

Parts nomenclature

- Check that the packing carton contains all of the component parts shown in the figure below before you begin to assemble the turntable.
- See page 7 for assembly procedures.

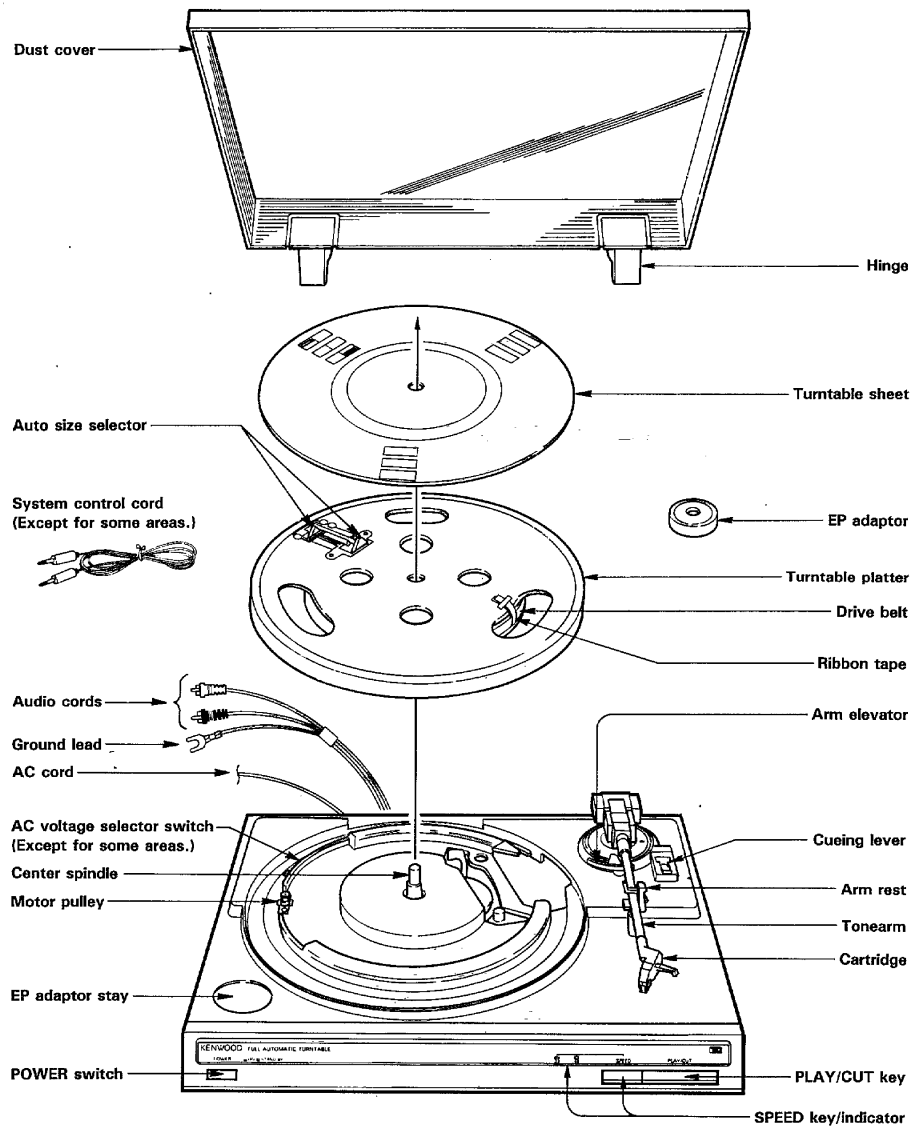

Assembly

■ How to set the turntable platter and turntable sheet

- 1 Set the turntable platter carefully on the center spindle.
- 2 Using the ribbon tape, engage the drive belt with the motor pulley as shown.
- 3 Remove the ribbon tape.

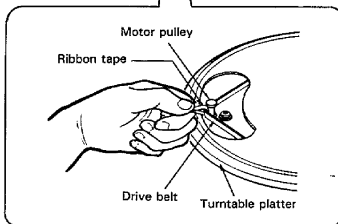

- 4 Place the turntable sheet on the turntable platter so that the detection notches of the auto size selector protrude from the holes in the turntable sheet.

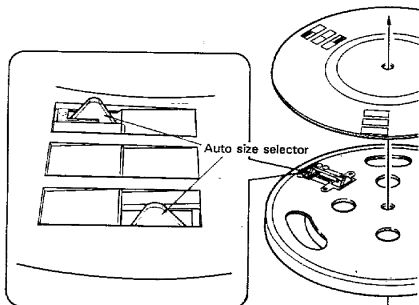

Releasing the arm rest lock lever

Remove the vinyl tie holding the tonearm to the arm rest, and unlock the lock lever in the direction of the arrow.

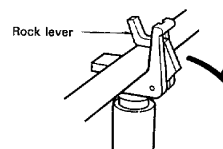

Using the stylus cover

Before operation, raise the stylus cover in the direction of the arrow.

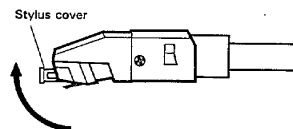

After record play, always lower the stylus cover to protect the stylus tip.

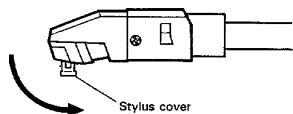

Connections

■ Connections

Turn off the power to your amplifier or receiver. Connect the audio cord, ground lead, system control cord, then the AC cord.

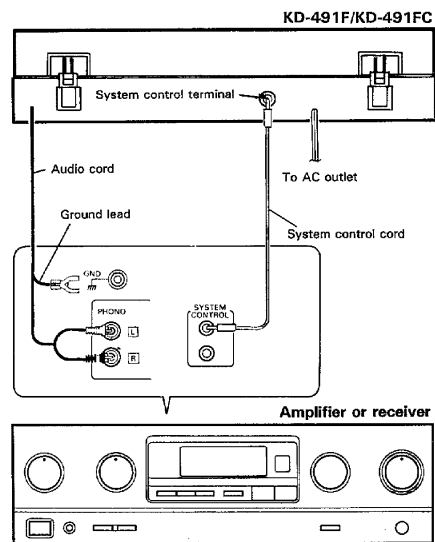

System control connection (Except for some areas.)

When connected to an amplifier or receiver having KENWOOD system control terminals, system operation such as remote control is made possible. For details, refer to the instruction manual of the amplifier or receiver.

If your amplifier or receiver is not equipped with the system control Terminals, do not connect anything to any system control Terminal.

Do not connect the unit in any system configuration other than specified.

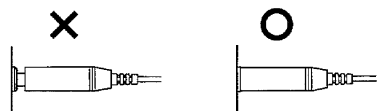

- Be sure to insert the system control cord plugs fully into the system control terminals.
- If the system control cord and audio cords are not connected properly, the automatic system governing remote control and system functions will not operate.

Setting the amplifier

This unit is equipped with an MM cartridge. Connect the audio cord of this unit to the PHONO MM jacks of the amplifier or set the cartridge load selector of the amplifier to MM.

- Notes:
1. As a microcomputer is used in this unit, beat noise may be generated when receiving broadcasts with the tuner. In such cases, turn off the power switch of this unit or adjust the tuner antenna.
 2. Incorrect ground lead connection may sometimes make it impossible to activate the system control operation.

For the U.S.A. FCC WARNING:

This equipment may generate or use radio frequency energy. Changes or modifications to this equipment may cause harmful interference unless the modifications are expressly approved in the instruction manual. The user could lose the authority to operate this equipment if an unauthorized change or modification is made.

NOTE:

This equipment has been tested and found to comply with the limits for a CLASS B digital device, pursuant to Part 15 of the FCC Rules. These limits are designed to provide reasonable protection against harmful interference in a residential installation. This equipment may cause harmful interference to radio communications, if it is not installed and used in accordance with the instructions. However, there is no guarantee that interference will not occur in a particular installation. If this equipment does cause harmful interference to radio or television reception, which can be determined by turning the equipment off and on, the user is encouraged to try to correct the interference by one or more of the following measures:

- Reorient or relocate the receiving antenna.
- Increase the separation between the equipment and receiver.
- Connect the equipment into an outlet on a circuit different from that to which the receiver is connected.
- Consult the dealer or an experienced radio/TV technician for help.

Operating instructions

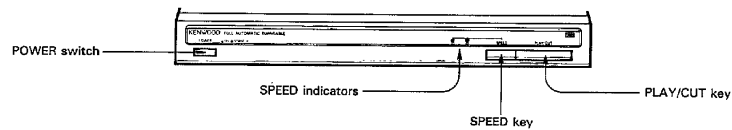

Automatic play

- 1 Turn the power on and set a record on the turntable platter.

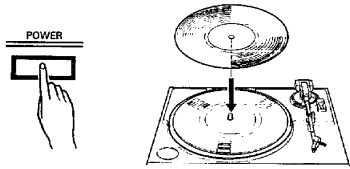

- 2 Select 33 1/3 or 45 by pressing the SPEED key.

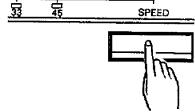

- 3 Confirm that the cueing lever is set to "▼".

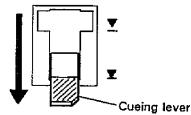

- 4 Press the PLAY/CUT key.

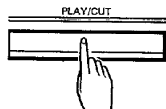

- Playing will start from the beginning of the record.

- 5 Control the volume by VOLUME control on the amplifier.

- At the end of the record, the tonearm returns to the arm rest and the turntable stops.

Note:
When the PLAY/CUT key is pressed with no record on the turntable platter, the platter starts rotating, then stops automatically.

To stop the play temporarily

Set the cueing lever to "▼" to momentarily stop playing. The tonearm leaves the record.

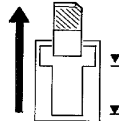

To restart playing, set the cueing lever to "▼". The record play resumes at over near the same position.

To stop playback operation

If you wish to stop play operation part way through a record, press the PLAY/CUT key.

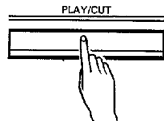

- The tonearm will automatically return to the arm rest, and the turntable platter will stop turning.

When playing a 17 cm (7 inch) record...

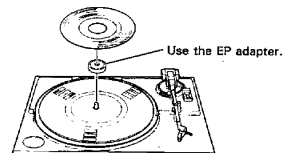

Note:
Manual operation is necessary for 25 cm records or other odd sizes.

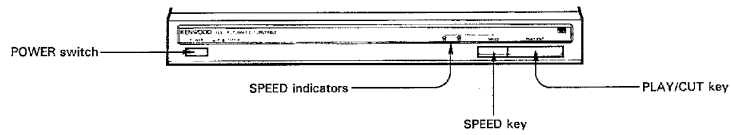

■ Manual play

1 Turn the power on and set a record on the turntable platter.

2 Select 33 1/3 or 45 by pressing the SPEED key.

3 Set the cueing lever to "▼".

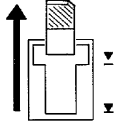

4 Swing the tonearm over the starting position.

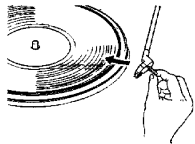

5 Set the cueing lever to "▼".

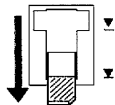

• This puts the tonearm on the record and playing starts.

6 Control the volume with the VOLUME control on the amplifier.

• At the end of the record, the tonearm returns to the arm rest and the turntable platter stops.

■ To stop the play temporarily

Set the cueing lever to "▼" to momentarily stop playing. The tonearm leaves the record.

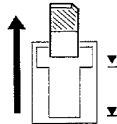

To restart playing, set the cueing lever to "▼". The record play resumes at over near the same position.

■ To stop playback operation

If you wish to stop play operation part way through a record, press the PLAY/CUT key firmly.

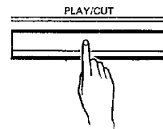

• The tonearm will automatically return to the arm rest, and the turntable platter will stop turning.

- Notes:
1. Record play cannot be started within a radial distance of 63 mm (2-1/2") from the center of the record.
 2. After play or during play, do not turn the power off until the tonearm returns to the arm rest and the turntable platter stops completely.

Maintenance

How to replace the cartridge

Obtain the optionally available  MM cartridge.

With this unit, a MC type cartridge cannot be used.

- 1 Set the POWER switch of the amplifier and turntable to OFF.
Remove the stylus assembly.
(To protect the stylus, remove the stylus assembly beforehand.)

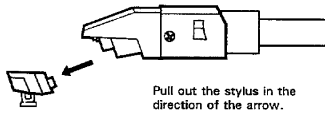

- 2 Remove the cartridge locking screw.

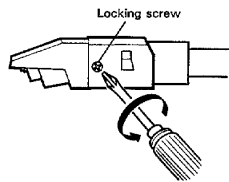

- 3 Pull out the cartridge from the tonearm.

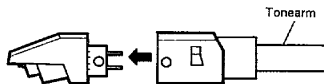

- To install the cartridge, align the pins of the cartridge with the connector of the tonearm and securely insert.

Stylus replacement

A replacement stylus can be obtained from your local dealer.

- 1 Set the POWER switch of the amplifier and turntable to OFF.
Pull out the stylus in the direction of the arrow shown in the figure.

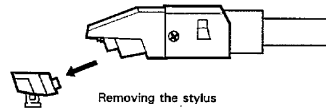

- 2 Replace with a new stylus (KENWOOD specified N-67BL) in the reverse order of step 1 above.

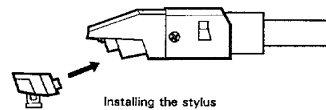

- When replacing the stylus, take care not to damage the stylus tip.

Motor lubrication

The built-in motor does not require lubrication.

Periodic check-up

Because a turntable is a mechanical device it is subject to the effects of wear and misadjustment that occurs due to normal handling. Even if your unit appears to function normally, a periodic check-up at intervals of two years or so is recommended to ensure a long service life and proper operation. Check with your dealer or authorized service representative.

In case of difficulty

What appears to be a malfunction may not always be serious. If your unit should not perform as expected, consult the table below to see if the problem can be corrected before seeking help from your dealer or service representative.

Symptom	Cause	Correction
No sound from both left and right channels or from one channel.	<ul style="list-style-type: none"> Turntable output cables disconnected. The function switch of the amplifier is not set to PHONO MM. 	<ul style="list-style-type: none"> Check connections to amplifier. Set the function switch to PHONO MM.
Loud hum, no music.	<ul style="list-style-type: none"> Poor connection of turntable output cables. 	<ul style="list-style-type: none"> Make solid connections to amplifier.
Loud hum with music.	<ul style="list-style-type: none"> Turntable output cables picking up hum from AC cord. The ground lead of the turntable is not connected to the GND terminal of the amplifier. 	<ul style="list-style-type: none"> Separate output cables from AC cord or reverse AC cord plug. Connect the ground lead to the GND terminal of the amplifier.
Buzzing noise with music.	<ul style="list-style-type: none"> Turntable output cables picking up TV signal. 	<ul style="list-style-type: none"> Relocate output cables for minimum pickup.
Howling drowns out music when volume is increased.	<ul style="list-style-type: none"> Speaker vibration is picked up by turntable. 	<ul style="list-style-type: none"> Separate turntable from speakers.
Turntable platter does not turn.	<ul style="list-style-type: none"> Poor AC plug contact. Drive belt does not engage with the motor pulley. 	<ul style="list-style-type: none"> Check connection. Make sure AC outlet is active. Engage the drive belt with the motor pulley.
Poor tracking.	<ul style="list-style-type: none"> Excessive dust on record or stylus. 	<ul style="list-style-type: none"> Remove dust from record or stylus.

Notes:

- As this system uses microprocessors, it may not function properly due to external noise or interference noise. If this happens, disconnect the power plug from the outlet, wait several seconds, then reconnect.
- Do not use contact cleaner because it could cause a malfunction. Be specially careful against contact cleaners containing oil, for they may deform the plastic components.

Specifications

Motor and Turntable

Drive System.....Belt-drive system
Motor.....DC Servo Motor
Turntable Platter.....30.1 cm (11-7/8") diameter
 0.31 kg (0.68 lb) weight
Speeds.....2 speeds, 33-1/3 and 45 rpm
Wow & Flutter.....0.05% (WRMS)
S/N (Rumble).....DIN: 68 dB (Weighted)

Tonearm

Type.....Static-Balanced Straight
 Tonearm
Effective Tonearm Length.....222 mm (8-3/4")
Overhang.....16 mm (5/8")

Cartridge

Furnished Cartridge.....T4P MM cartridge (V-67BL)
Frequency Response.....20 ~ 20,000 Hz
Output Voltage.....2.5 mV
 (1,000 Hz, 5 cm/sec)
Load Impedance.....47 k Ω
Stylus.....N-67BL with 0.6 mil diamond
Optimum Tracking Force.....1.25 grams
Compliance..... 7×10^{-6} cm/dyne

Miscellaneous

Power Consumption.....6 W
Dimensions.....W: 440 mm (17-5/16")
 H: 106 mm (4-3/16")
 D: 390 mm (15-3/8")
Weight (Net).....3.4 kg (7.5 lb)

Note:

KENWOOD follows a policy of continuous advancements in development. For this reason specifications may be changed without notice.